

EN60598 IK08 IP66   

RIM 1024 07 740 R0 600 9006 0 * xx

RIMANO

Due to latest LED technology, proven technology of street lighting and the reduced weight of the luminaire the LED street light RIMANO offers maximum adaptability to individual lighting applications. Therefore RIMANO is not only cost- and energy-efficient but also easy to install and maintain.



Technical Data

Material	AlSi12, Top: Polycarbonat (AlSi12 on request)
Housing color	RAL 9006
Glass cover	safety flat glass
Application / optics	normal wide / R0
LED lifetime	L80 > 100 000 h
SDCM	MacAdam 5
Mounting	Side entry / Post top combined
Bracket diameter	42 / 60 / 76 mm (to be defined at order)
Tilting angle	+ 10° to -20° / +20°, adjustable in 5° steps
Weight	9,7 kg
Windage Area	0,067 m ²
Temperature	-40°C to +50°C
Nominal voltage	220 - 240 VAC 50/60 Hz

Light file

RIM 1024 740 R0 600

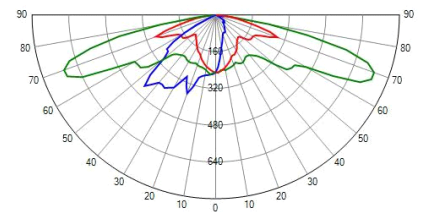

more on the Internet



Specific data

Color temperature	4000 K
CRI	75
System light output	4910 lm
Power consumption	46,2 W
∅ 0 h - 80 000 h	48,4 W
> 80 000 h	50,7 W
System efficacy	106 lm/W
LED current	600 mA
cos Phi	0,93
Driver typ	TR60
Surge protection	10kV / 6 kV ¹
Inrush current	53 A

* Functions (more on request)

- 21 on / off
- 25 Luna Dimmer
- 33 Dali integrated

all values at Ta =25°C

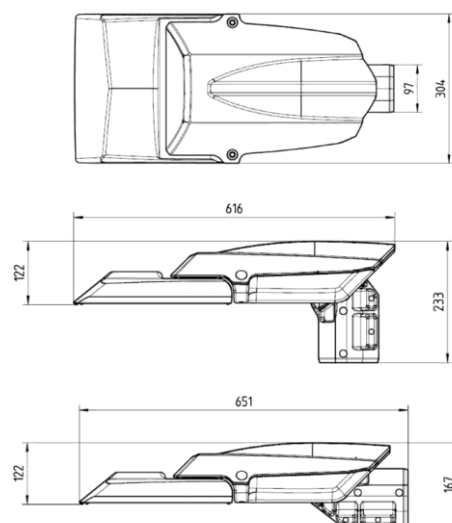
¹ Common Mode / Differential Mode

Dimensional Drawing in mm